

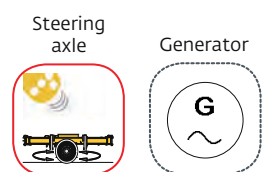

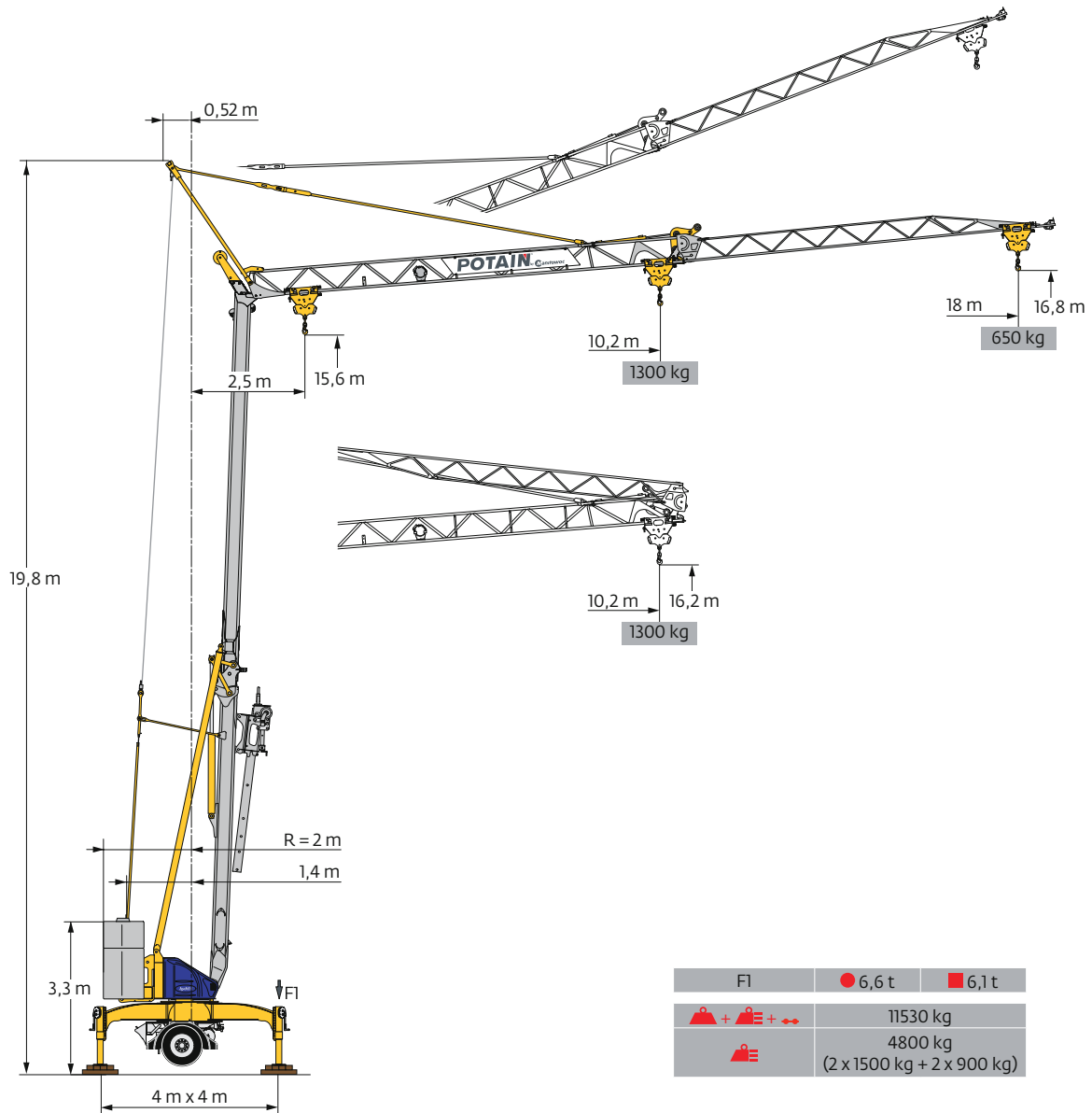

## Igo M 11

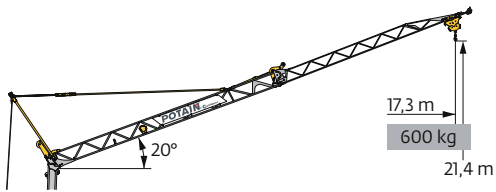

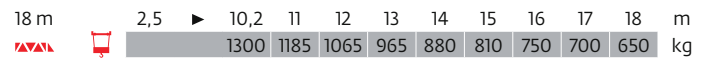
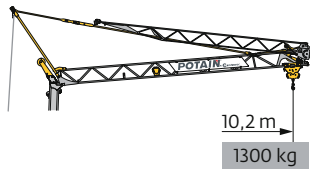

Courbes de charges / Lastkurven / Load curves / Curvas de cargas / Curve di carico  
Curvas de carga / Кривые нагрузок



Mécanismes / Triebwerke / Mechanisms / Mecanismos / Meccanismi  
Mecanismos / Механизмы

230 V - 50 Hz 400 V - 50 Hz 480 V - 60 Hz							ch - PS hp	kW
	<b>6 LVF 7 Optima</b>	230 V $\pm$	m/min	$\uparrow$ 3,5	$\uparrow$ 5 $\downarrow$ 12	$\uparrow$ 16,5 $\downarrow$ 42,5	3,3	2,4
		20 A <b>1</b>	kg	1300	1300	500		
		230 V $\pm$	m/min	$\uparrow$ 3,5	$\uparrow$ 7 $\downarrow$ 12	$\uparrow$ 29 $\downarrow$ 42,5	5,2	3,8
		32 A <b>2</b>	kg	1300	1300	500		
		400 V $\pm$	m/min	$\uparrow$ 3,5	$\uparrow$ 12 $\downarrow$ 42,5	$\uparrow$ 35 $\downarrow$ 42,5	5,5	4
		480 V <b>3</b>	kg	1300	1300	500		
	<b>1 D1 V3</b>		m/min	24			1,5	1,1
	<b>RVF 20</b>		tr/min U/min rpm	0 $\rightarrow$ 1			1,5	1,1

 IEC 60204-32	 kVA
230 V (+10% -10%) 50 Hz 400 V (+10% -10%) 50 Hz 480 V (+6% -10%) 60 Hz	230 V 20 A : 4,6 kVA 230 V 32 A : 7,4 kVA 400 V / 480 V : 9,5 kVA

**6 LVF 7 Optima**

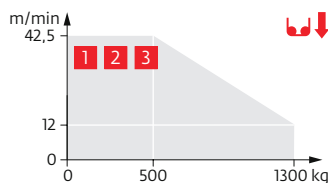
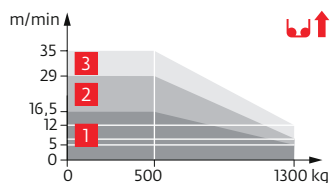

Montage / Montage / Erection / Montaje / Montaggio  
Montagem / Монтаж

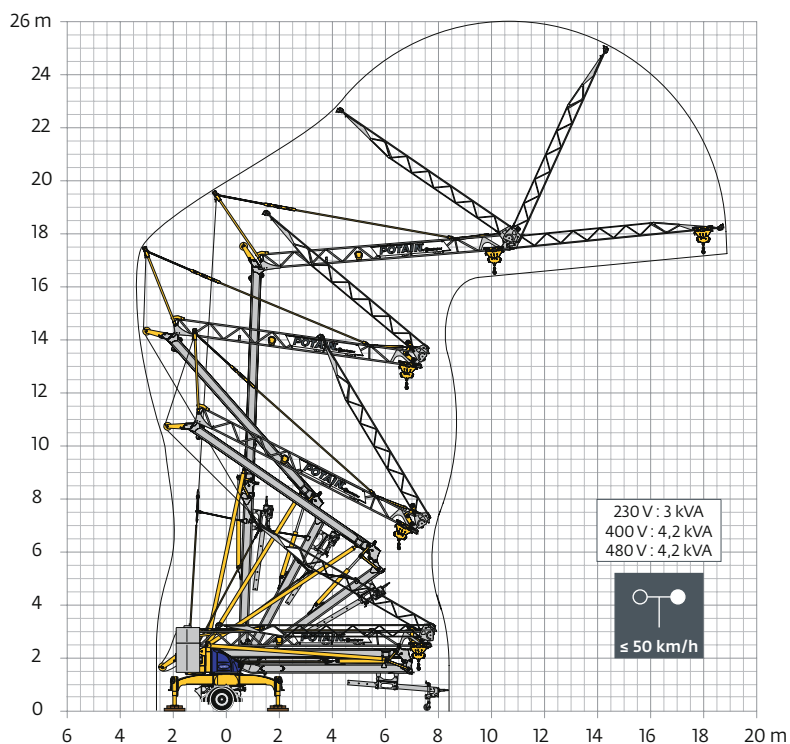

Transport / Transport / Transport / Transporte / Trasporto  
Transporte / Транспортировка

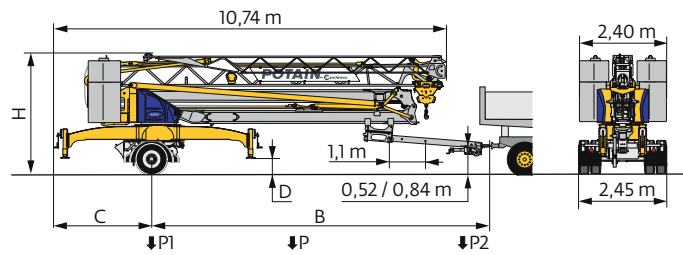

	km/h	B (m)	C (m)	D (m)	H (m)	P (kg)	P1 (kg)	P2 (kg)
T11/J136	25	8,57 / 9,67	2,75	0,43	3,3	11530	10750	780

	FR	DE	EN	ES	IT	PT	RU
R	Rayon de giration	Schwenk radius	Rear slewing radius	Radio de giro	Raggio di rotazione	Raio de rotação	Задний габарит
	Réactions en service	Reaktionskräfte in Betrieb	Reactions in service	Reacciones en servicio	Reazioni in servizio	Reacções em serviço	Реакция при работе
	Réactions hors service	Reaktionskräfte außer Betrieb	Reactions out of service	Reacciones fuera de servicio	Reazioni fuori servizio	Reacções fora de serviço	Реакция в покое
	Poids à vide, sans lest, sans trains de transport, avec flèche maxi. et hauteur standard.	Gewicht ohne Last, ohne Ballast, ohne Transportachsen, mit max. Auslager und Standardhöhe	Weight without load, without ballast, without transport axes, with max. jib and standard height	Peso en vacío, sin lastre, sin trenes de transporte con flecha y altura estándar	Peso a vuoto, senza zavorra, senza assali di trasporto, con braccio max e altezza standard.	Peso em vazio, sem lastro, sem eixos de transporte com lança máxima e altura standard.	Вес без груза, без балласта, без осей для транспортировки, с максимальным вылетом стрелы и стандартной высотой
	Poids total du lest	Ballast-Gesamtgewicht	Total ballast weight	Peso total del lastre	Peso totale della zavorra	Peso total do lastro	Общий вес балласта
	Équipements standards	Standardausrüstungen	Standard equipment	Equipamiento de serie	Equipaggiamento standard	Equipamento de série	Стандартное оборудование
	Équipements optionnels	Sonderausrüstungen	Options	Equipamiento opcional	Equipaggiamento in opzione	Equipamento opcional	Дополнительное оборудование (опция)
	Trains de transport	Transportachsen	Transport axes	Trenes de transporte	Assali di trasporto	Eixos de transporte	Осей для транспортировки
	Levage	Heben	Hoisting	Elevación	Sollevamento	Elevação	Подъем
	Distribution	Katzfahren	Trolleying	Distribución	Distribuzione	Distribuição	Перемещение по стреле
	Orientation	Schwenken	Slewing	Orientación	Rotazione	Rotação	Поворот
	50 Hz Monophasé	50 Hz Einphasige	50 Hz Single phase	50 Hz Monofasica	50 Hz Monofase	50 Hz monofásica	Однофазное напряжение 50Hz
	Puissance requise	Erforderliche Leistung	Required power	Potencia Necesaria	Potenza richiesta	Potência Necessária	Потребляемая мощность
	Transport grue toute lestée.	Krantransport mit voller Ballastierung.	Transport of crane with full ballast.	Transporte grúa completamente lastrada.	Trasporto con gru completamente zavorrata.	Transporte de grua totalmente balastada.	Перевозка крана с полным балластом
	Document commercial non contractuel. Pour toute information technique se référer à la notice correspondante.	Unverbindliches Vertriebsdokument. Für technische Informationen, siehe die entsprechenden Anweisungen.	This commercial document is not legally binding. For any technical information, please refer to the corresponding instructions.	Documento comercial no contractual. Para cualquier información técnica, ver la noticia correspondiente.	Documento commerciale non vincolante, per tutte le informazioni tecniche fare riferimento al catalogo istruzioni.	Documento comercial não contratual. Para qualquer informação técnica complementar consultar as respectivas instruções.	Этот коммерческий документ не является юридически обязательным. Для получения технической информации, см. соответствующие инструкции.

